

MODEL ROCKET TRACKING AND TELEMETRY TRANSMITTER KIT

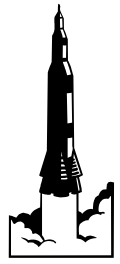

Ramsey Electronics Model No.

MR6

Easily track your rocket using a scanner receiver. Uses SMT (surface mount technology) components for the ultimate in miniaturization and performance.

**INCLUDES
BATTERIES**

*Actual Size of
Assembled Kit
With Battery*

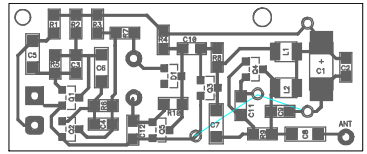

- Talk about small - this baby's *MICRO* size !
- Get some "hands on" experience with the latest surface mount technology.
- Crystal controlled - NO FREQUENCY DRIFT !
- Not small on performance - transmits up to 1/4 mile !
- Kit includes extra SMT components - no worries about losing or dropping a tiny part.
- Unit powered by a 3 V lithium camera battery (included) available at any camera or discount store.
- Complete and informative instructions guide you to a kit that works the first time, every time - enhances resale value, too !
- Transmits in the 146.00 MHz range, receive on any scanner or 2 Meter ham rig

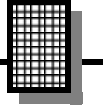

RAMSEY TRANSMITTER KITS

- FM10A, FM25B FM Stereo Transmitters
- TV6 TV Transmitter
- AM1, AM25 AM Transmitters

RAMSEY RECEIVER KITS

- FR1 FM Broadcast Receiver
- AR1 Aircraft Band Receiver
- SR2 Shortwave Receiver
- AA7 Active Antenna

RAMSEY HOBBY KITS

- SG7 Personal Speed Radar
- SS70A Speech Scrambler
- BS1 "Bullshooter" Digital Voice Storage Unit
- AVS10 Automatic Sequential Video Switcher
- WCT20 Cable Wizard Cable Tracer
- LABC1 Lead Acid Battery Charger
- ECG1 Heart Monitor
- VG1 Van deGraff Generator
- SP1 Speakerphone
- MD3 Microwave Motion Detector
- PH10 Peak Hold Meter
- TFM3 Tri-Field Meter

RAMSEY AMATEUR RADIO KITS

- HR Series HF All Mode Receivers
- QRP Series HF CW Transmitters and Power Amplifiers
- CW7 CW Keyer
- DDF1 Doppler Direction Finder

RAMSEY KITS

The above is but a small listing of available Ramsey kits, many other kits are available for hobby, school, Scouts and just plain FUN. New kits are always under development. Write or call for our free Ramsey catalog.

MR6 MODEL ROCKET TRACKING TRANSMITTER KIT INSTRUCTION MANUAL

Ramsey Electronics Publication No. MMR6 Revision 1.0A

First printing: November 2000



COPYRIGHT ©1995 by Ramsey Electronics, Inc. 590 Fishers Station Drive, Victor, New York 14564. All rights reserved. No portion of this publication may be copied or duplicated without the written permission of Ramsey Electronics, Inc. Printed in the United States of America.

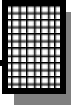

KIT ASSEMBLY AND INSTRUCTION MANUAL FOR

MR6 MODEL ROCKET TRACKING AND TELEMETRY TRANSMITTER

TABLE OF CONTENTS

Introduction to the MR6.....	4
How it works.....	4
SMT soldering instructions.....	5
Parts list	7
Parts Layout diagram.....	8
Schematic diagram	9
MR6 Assembly instructions.....	10
Hook-up configurations	13
Troubleshooting	13
Ramsey kit warranty	15



RAMSEY ELECTRONICS, INC.
590 Fishers Station Drive
Victor, New York 14564
Phone (585) 924-4560
Fax (585) 924-4555
www.ramseykits.com

INTRODUCTION

Welcome to the latest innovation in electronics technology using (S)urface (M)ount (T)echnology, or SMT. Just as when the transistor revolutionized the amount of space required to construct electronic circuits, the advent of surface mount components have further “shrunk” the dimensions of what we are accustomed to seeing in modern day circuits. These “chip” components are commonly used in today’s miniature circuits including everything from camcorders to high speed computers. We wanted to design a kit that accentuated their small size, so what better than a micro FM transmitter! Many low cost wireless transmitters are susceptible to frequency drift when held in the hand, placed on a metal table or subject to close proximity of a body. This kit uses crystal control to reduce any possibility of frequency drift.

While this kit and manual were designed with the beginner in mind, it should also be stated that this kit qualifies as a “Skill Level 2” due to the nature of the assembly using surface mount components. While this isn’t intended to “scare you off” it is not recommended that this be your first electronics assembly project. While we have included extra SMT components in case you lose or damage a “chip” component, care should still be taken to assemble the kit with the utmost care - an uncontrolled sneeze could blow your kit away!

While the components may seem strange looking at first (where are the leads??!!) rest assured that they are not too difficult to install. A friendly warning, however, don’t pull out your trusty soldering gun for this project (our repair techs have a pet statement, “do you know what the soldering gun’s light is for - it’s to see what you’re burning up!”) as the gun generates too much heat for the tiny solder “tabs” on the component ends. A small pair of tweezers and good eye to hand coordination are also necessary for proper assembly of this kit. A magnifying lens is recommended to check solder connections.

MR6 CIRCUIT DESCRIPTION

The MR6 is a three stage crystal controlled transmitter consisting of a crystal oscillator followed by two frequency multipliers. The crystal oscillator operates at 12, 16 or 24 MHz, depending upon crystal used. The first frequency multiplier is tuned to the fourth, third or second harmonic of the crystal oscillator, producing a strong output at 1/3 of the final 146 MHz output frequency. The second frequency multiplier operates as a frequency tripler, producing the desired 146 MHz output frequency. Broadband coupling is used to allow the user to select different crystals for various output frequencies.

RAMSEY Learn-As-You-Build KIT ASSEMBLY

There are numerous solder connections on the MR6 printed circuit board. Therefore, PLEASE take us seriously when we say that good soldering is essential to the proper operation of your transmitter!

- Use a 25-50 watt soldering pencil with a clean, sharp tip.
- Use only rosin-core solder intended for electronics use.
- Use bright lighting, a magnifying lamp or bench-style magnifier may be helpful.
- Do your work in stages, taking breaks to check your work. Brush away wire cuttings so they don't lodge between solder connections.

We have a two-fold "strategy" for the order of the following kit assembly steps. First, we install parts in physical relationship to each other, so there's minimal chance of placing parts on the wrong pads. Second, whenever possible, we install in an order that fits our "Learn-As-You Build" Kit building philosophy.

For each part, our word "Install" always means these steps:

1. Pick the correct part value to start with.
2. Place it on to the correct PC board location.
3. Orient it correctly, follow the PC board drawing and the written directions for all parts - especially when there's a right way and a wrong way to solder it in. (Diode bands, electrolytic capacitor polarity, transistor shapes, dotted or notched ends of IC's, and so forth.)
4. Solder all connections unless directed otherwise. Use enough heat and solder flow for clean, shiny, completed connections.

SURFACE MOUNT COMPONENT SOLDERING INSTRUCTIONS:

You'll notice that the circuit board contains only a few holes for component leads to pass through. This is because the SMT components will be affixed to the "solder" side of the PC board, the side that contains the PC traces. Be aware that the component view for assembly is looking at the solder side of the PC board.

Patience is the key when installing surface mount components. Typically, the first step (after identifying the component) is to "tin" one of the PC traces that will connect to the part. Once this is accomplished, the part can be installed by holding it with tweezers in contact with the "tinned" trace and re-heating

the solder (see the associated diagrams).

Another commonly used technique is to glue the surface mount components to the printed circuit board before soldering. The procedure is to take a small amount of glue (usually with a pin or toothpick) and "dab" the circuit board in the place where the component will be affixed. Be careful not to apply too much glue as when the part is placed it may "squash" the glue underneath the soldering tabs of the component. Carefully place the part into position,

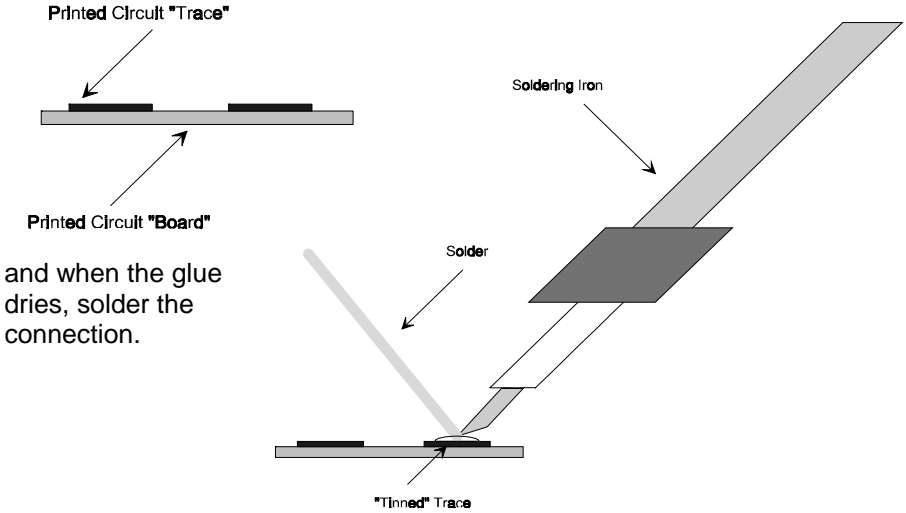

This may go a little "against the grain" at first, but it is by far the easiest method. Notice also that when reheating the solder that the iron tip does not come in contact with the "tab" on the body of the chip component. Over heating of this solder tab can cause a fracture of the bond to the component, causing an intermittent connection.

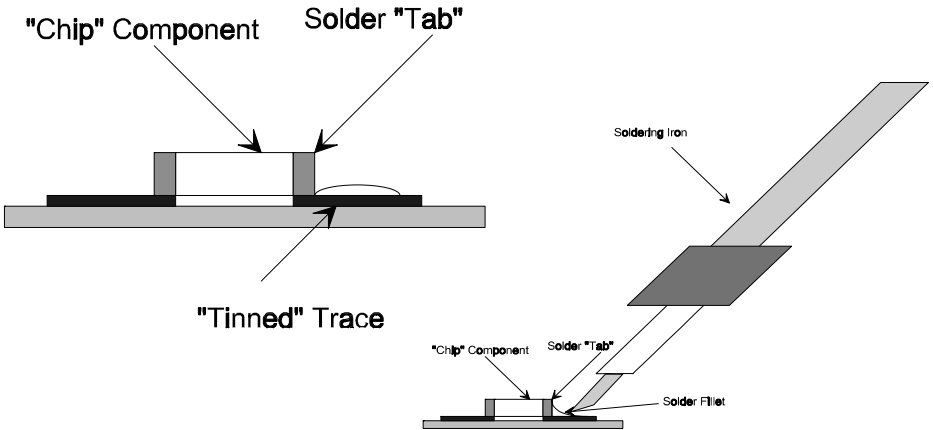

MR6 PARTS LIST Note the extra chip components included.

RESISTORS

- 4 1K ohm chip resistors (R2,3,4)
- 3 10K ohm chip resistors (R1,7)
- 7 100K ohm chip resistor (R5,6,8,9,10)

CAPACITORS

- 7 5 pF chip capacitors (C7,8,9,11)
- 2 22 pF chip capacitor (C12)
- 3 100 pF chip capacitor (C3,4)
- 3 .001 uF chip capacitor (C2,10)
- 3 .1 uF chip capacitor (C5,6)
- 1 10 uF electrolytic chip capacitor (C1)

SEMICONDUCTORS

- 3 MMBTH10L chip NPN transistors [marked 3E] (Q3,4)
- 4 MMBTA20L chip NPN transistors [marked 1C] (Q1,2,5)
- 2 MMBV2109 chip varactor diode [marked 4J] (D1)

INDUCTORS

- 1 .10 uH chip inductor [marked R10 or 101K - in tiny letters!] (L2)
- 1 .15 uH chip inductor [marked 151K - in tiny letters!] (L1)

MISCELLANEOUS PARTS AND HARDWARE

- 1 MR6 printed circuit board
- 1 3 Volt Lithium camera battery
- 1 Battery holder (BH1)
- 1 Crystal, 12, 16 or 24 MHz (Y1)
- 18 inches insulated wire for antenna lead

Top side of MR6 (SMT Side):

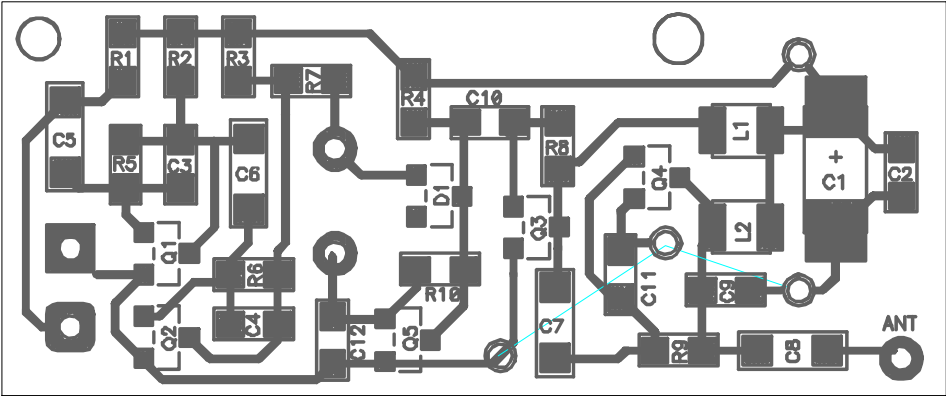

Bottom side of MR6:

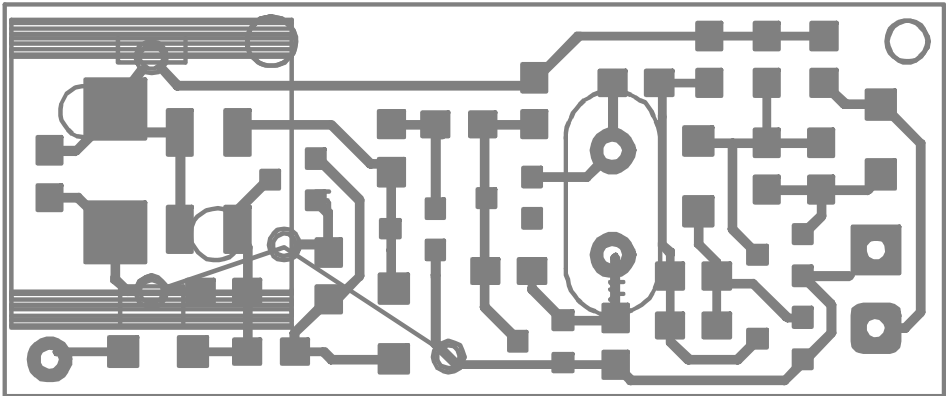

SCHEMATIC DIAGRAM:

Now, let's get building!

First, we'll install the "normal" parts that mount on the "component" side of the circuit board with their leads passing through to the "solder" side of the board. This will also help us to get acquainted with the up - down, left - right orientation of the circuit board. Remember that the chip components will be mounted on the solder side of the circuit board so only use the amount of solder necessary to make the connection, being careful not to "flood" the circuit board traces with solder.

- 1. Sort your surface mount components by type to make it easier when installing. The parts are in marked bags that are easily identifiable. The markings on the individual parts will be explained when the part is installed.
- 2. Install crystal Y1, marked 12, 16 or 24.
- 3. Install the black plastic battery holder. Note the polarity markings on the holder and install correctly.

Now you'll begin soldering the surface mount components to the solder side of the circuit board. If there is any question as to how they should be installed, review the surface mount soldering instructions. For correct positioning, consult the component layout diagram.

- 4. Install C1, 10 uF electrolytic capacitor, orient the marked '+' side as shown.
- 5. Install C2, .001 uF chip capacitor.
- 6. Install L2, .10 uH chip inductor. If you look very closely, you'll see that it is marked either R10 or 101K in very tiny letters! Inside of that little body is a very small coil of wire.
- 7. Install L1, .15 uH chip inductor, marked 151K in little, tiny letters.
- 8. Install C9, 5 pF chip capacitor.
- 9. Install C8, 5 pF chip capacitor.
- 10. Install R9, 100K ohm chip resistor.
- 11. Install C11, another 5 pF chip capacitor.
- 12. Install Q4, the MMBTH10L NPN surface mount transistor (marked 3E). Be sure to orient it as shown in the parts placement diagram. Those sure are small mounting "tabs", aren't they!
- 13. Install C7, the last 5 pF chip capacitor.

- ❑ 14. Install Q3, another MMBTH10L NPN surface mount transistor (marked 3E). Once again orient it as shown in the parts placement diagram.
- ❑ 15. Install R8, 100K ohm chip resistor.

This completes the frequency multiplier portion of the MR6. We're actually working our way backwards through the transmitter, from antenna to the oscillator input. Take a break now to carefully examine all solder connections, especially around the transistors. It's much easier to find a problem now, before all parts are on the PC board.

- ❑ 16. Install C10, .001 uF chip capacitor.
- ❑ 17. Install D1, MMBV2109 chip varactor diode, marked 4J.
- ❑ 18. Install R10, 100K ohm chip resistor.
- ❑ 19. Install R4, 1K ohm chip resistor.
- ❑ 20. Install Q5, MMBTA20L chip transistor, marked 1C.
- ❑ 21. Install C12, 22 pF chip capacitor.
- ❑ 22. Install R7, 10K ohm chip resistor.
- ❑ 23. Install R3, 1K ohm chip resistor.
- ❑ 24. Install R2, another 1K ohm chip resistor.
- ❑ 25. Install R1, a 10K ohm resistor.
- ❑ 26. Install C5, .1 uF chip capacitor.
- ❑ 27. Install R5, 100K ohm chip resistor.
- ❑ 28. Install C3, 100 pF chip capacitor.
- ❑ 29. Install C6, .1 uF chip capacitor.
- ❑ 30. Install Q1, MMBTA20L chip transistor, marked 1C.
- ❑ 31. Install Q2, another MMBTA20L chip transistor, marked 1C.
- ❑ 32. Install R6, 100K ohm chip resistor.
- ❑ 33. Install C4, 100 pF chip capacitor.
- ❑ 34. Locate the piece of insulated wire. Using your soldering iron, tin one end of the wire and insert it into the hole labeled 'ANT' on the PC board.

CONGRATULATIONS

You have just completed your MR6 model rocket tracking unit. Take a well deserved break now. Give your eyes a rest. When you return, be sure to check over your work on the entire circuit board. Energizing the circuit board with solder “bridges” or misplaced components can damage your kit.

MR6 SET-UP AND TESTING INSTRUCTIONS

- 1. Tune a scanner, two meter ham rig or other such receiver to 146 MHz.
- 2. Install the 3 volt “button” type battery into the battery holder, be sure to observe the proper polarity when inserting the battery.
- 3. You should hear the MR6’s carrier signal. Adjust the frequency of the receiver slightly for best signal. You may find the actual received signal 5 to 50 KHz different from 146.000 MHz (146.00 to 147.00 KHz).

ANTENNA CONSIDERATIONS

The antenna consists of a length of enameled wire soldered to the antenna connection. It may be as short as 5 inches to give satisfactory results. Maximum range will be achieved by a length of 17 to 20 inches.

TROUBLESHOOTING HINTS

While we had hoped that it wouldn’t come to this, if you are having trouble with your transmitter, here are a few suggestions:

Use a methodical, logical troubleshooting technique. Most problems can be solved using common sense. A volt-ohm meter and a clear head are usually all that are needed to correct any problem. For example, all the NPN transistors have the emitter leads grounded, so the base lead should be at 0.7 VDC. Is there voltage present at the collectors of all transistors? The crystal oscillator is operating in a frequency range easily picked up by a nearby shortwave radio, see if you can receive it. Please understand that it is nearly impossible to “troubleshoot” by phone, any specific questions should be documented and sent to us by mail.

PLEASE READ THIS IMPORTANT INFORMATION

The MR6 operates in the 2 meter Amateur radio band and should be used by or under the direction of a properly licensed ham operator.

DATA INPUT IDEAS:

The easiest way to use your MR6 is to tune your 2 meter scanner or receiver until you hit the “dead spot” indicating that it is receiving the carrier from your kit. Turning the MR6 off will confirm that you’re on the right frequency. You may want to get a little more creative with your MR6 and have something to listen for other than quieting. The following are a few ideas that you may want to try using a simple 555 timer circuit. If you don’t know where to get a 555 IC, our UT5 mini kit is based on this versatile chip and includes the PC board and other components you may need at a reasonable price.

In the circuit shown below the tone is adjusted by R4, the 100K pot. Simply connect the output to the oscillator input of the MR6 and vary the pot until you get a tone you like. Of course, changing the value of the pot or some of the other components will change the oscillator and therefore the audio tone. Try different values and adjustments until you find the best sound for your application

A CDS photocell can be placed across the potentiometer from the junction

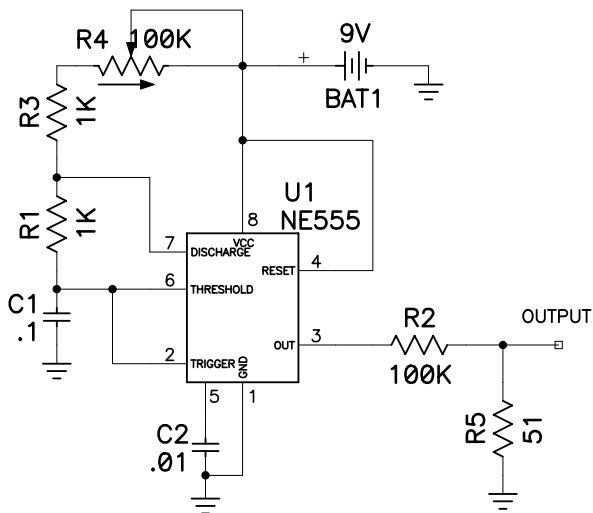

Ground from circuit above connects here.
Output of circuit above connects here

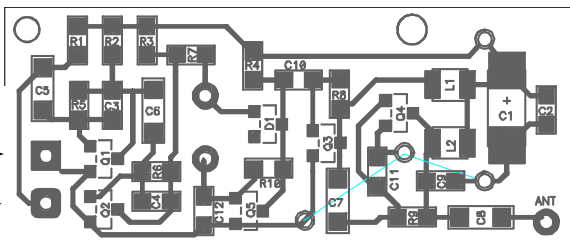

with R3 to the junction with the battery positive point. Because the resistance of the photocell changes according to how much light is present, this will cause the audio tone to change as well. In the same way you can try placing a thermistor either across R4 or in place of it (depending on the value of the thermistor). Thermistors are devices whose resistance changes depending on temperature. Be creative! Experiment! That's what Ramsey kits are all about.

CHANGING YOUR CRYSTAL

It is possible to change the frequency of your MR6 kit in two ways. The first is to change the value of C12. Increasing or decreasing the value of C12 will cause the circuit to oscillate at a slightly different frequency. Remember that you'll still be in the 2 meter band, since that's what the kit was designed for. The other way to change the frequency is to change the crystal. The schematic shows the different multiplication factors for different common crystals. If you need to order a crystal, one of the places you can call is Jan Crystal at 800-JAN-XTAL. The specifications you need are as follows: parallel resonant, 32pF load capacitance, HC-18/U holder, wire leads.

CONCLUSION

We sincerely hope that you have enjoyed the construction and use of this Ramsey Kit. As always, we have tried to compose our manual in the easiest, most "user friendly" format that is possible. As our customers, we value your opinions, comments, and additions that you would like to see in future publications. Please submit comments or ideas to:

Ramsey Electronics Inc.
590 Fishers Station Drive
Victor, NY 14564

And once again, thanks from the folks at Ramsey!

The Ramsey Kit Warranty

Please read carefully BEFORE calling or writing in about your kit. Most problems can be solved without contacting the factory.

Notice that this is not a "fine print" warranty. We want you to understand your rights and ours too! All Ramsey kits will work if assembled properly. The very fact that your kit includes this new manual is your assurance that a team of knowledgeable people have field-tested several "copies" of this kit straight from the Ramsey Inventory. If you need help, please read through your manual carefully, all information required to properly build and test your kit is contained within the pages!

1. DEFECTIVE PARTS: It's always easy to blame a part for a problem in your kit, Before you conclude that a part may be bad, thoroughly check your work. Today's semiconductors and passive components have reached incredibly high reliability levels, and its sad to say that our human construction skills have not! But on rare occasion a sour component can slip through. All our kit parts carry the Ramsey Electronics Warranty that they are free from defects for a full ninety (90) days from the date of purchase. Defective parts will be replaced promptly at our expense. If you suspect any part to be defective, please mail it to our factory for testing and replacement. Please send only the defective part (s), not the entire kit. The part(s) MUST be returned to us in suitable condition for testing. Please be aware that testing can usually determine if the part was truly defective or damaged by assembly or usage. Don't be afraid of telling us that you 'blew-it', we're all human and in most cases, replacement parts are very reasonably priced.

2. MISSING PARTS: Before assuming a part value is incorrect, check the parts listing carefully to see if it is a critical value such as a specific coil or IC, or whether a RANGE of values is suitable (such as "100 to 500 uF"). Often times, common sense will solve a mysterious missing part problem. If you're missing five 10K ohm resistors and received five extra 1K resistors, you can pretty much be assured that the '1K ohm' resistors are actually the 'missing' 10 K parts ("Hum-m-m, I guess the 'red' band really does look orange!") Ramsey Electronics project kits are packed with pride in the USA. If you believe we packed an incorrect part or omitted a part clearly indicated in your assembly manual as supplied with the basic kit by Ramsey, please write or call us with information on the part you need and proof of kit purchase.

3. FACTORY REPAIR OF ASSEMBLED KITS:

To qualify for Ramsey Electronics factory repair, kits MUST:

1. NOT be assembled with acid core solder or flux.
2. NOT be modified in any manner.
3. BE returned in fully-assembled form, not partially assembled.
4. BE accompanied by the proper repair fee. No repair will be undertaken until we have received the MINIMUM repair fee (1/2 hour labor) of \$25.00, or authorization to charge it to your credit card account.
5. INCLUDE a description of the problem and legible return address. DO NOT send a separate letter; include all correspondence with the unit. Please do not include your own hardware such as non-Ramsey cabinets, knobs, cables, external battery packs and the like. Ramsey Electronics, Inc., reserves the right to refuse repair on ANY item in which we find excessive problems or damage due to construction methods. To assist customers in such situations, Ramsey Electronics, Inc., reserves the right to solve their needs on a case-by-case basis.

The repair is \$50.00 per hour, regardless of the cost of the kit. Please understand that our technicians are not volunteers and that set-up, testing, diagnosis, repair and repacking and paperwork can take nearly an hour of paid employee time on even a simple kit. Of course, if we find that a part was defective in manufacture, there will be no charge to repair your kit (But please realize that our technicians know the difference between a defective part and parts burned out or damaged through improper use or assembly).

4. REFUNDS: You are given ten (10) days to examine our products. If you are not satisfied, you may return your unassembled kit with all the parts and instructions and proof of purchase to the factory for a full refund. The return package should be packed securely. Insurance is recommended. Please do not cause needless delays, read all information carefully.

MODEL ROCKET TRACKING TRANSMITTER Quick Reference Page Guide

Introduction to the MR6	4
How it works	4
SMT soldering instructions	5
Parts list	7
Parts Layout diagram.....	8
Schematic diagram	9
MR6 Assembly instructions	10
Hook-up configurations.....	13
Troubleshooting	13
Ramsey kit warranty	15

REQUIRED TOOLS

- Soldering Iron Ramsey WLC100
- Thin Rosin Core Solder Ramsey RTS12
- Needle Nose Pliers Ramsey MPP4 or RTS05
- Small Diagonal Cutters Ramsey RTS04
- <OR> Technician's Tool Kit TK405

ADDITIONAL SUGGESTED ITEMS

- Holder for PC Board/Parts Ramsey HH3
- Desoldering Braid Ramsey RTS08
- Digital Multimeter Ramsey M133

Price: \$5.00

Ramsey Publication No. MMR6

Assembly and Instruction manual for:

**RAMSEY MODEL NO. MR6 MODEL ROCKET
TRACKING TRANSMITTER KIT**



RAMSEY ELECTRONICS, INC.

590 Fishers Station Drive

Victor, New York 14564

Phone (585) 924-4560

Fax (585) 924-4555

www.ramseyelectronics.com