

ALL EXPOSED EDGES MUST BE COVERED WITH 1/4 WALNUT EDGING  
 NOTES: FINISH - ALL WALNUT SURFACES MUST HAVE 3 COATS OIL-WAX  
 ALL WALNUT EDGING TO HAVE 1/8 RAD.

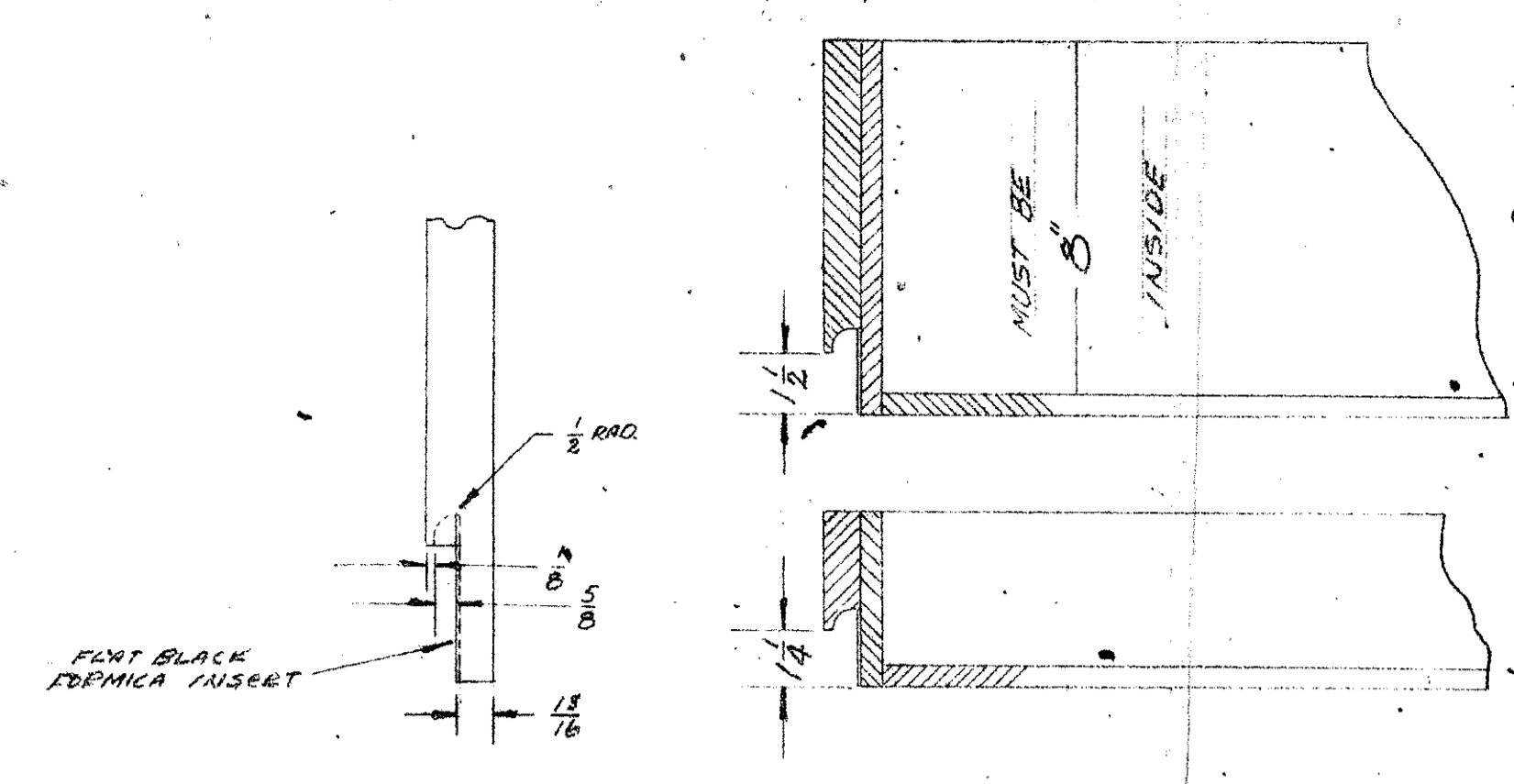

DRILL A 1" DIA HOLE 1" BACK OF TOP DRAWER

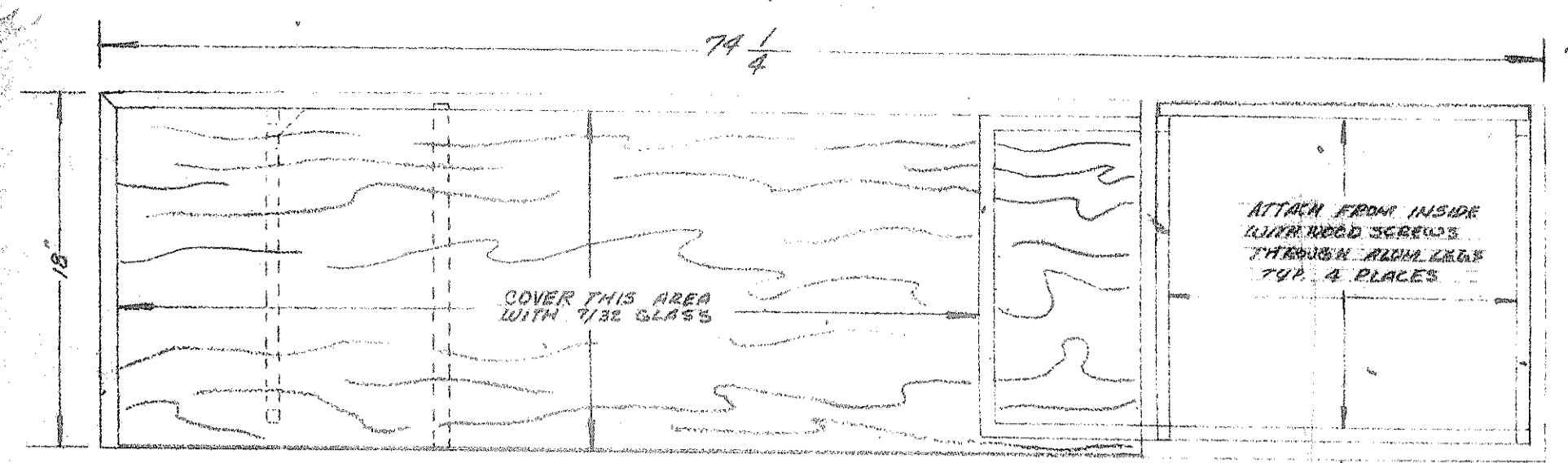
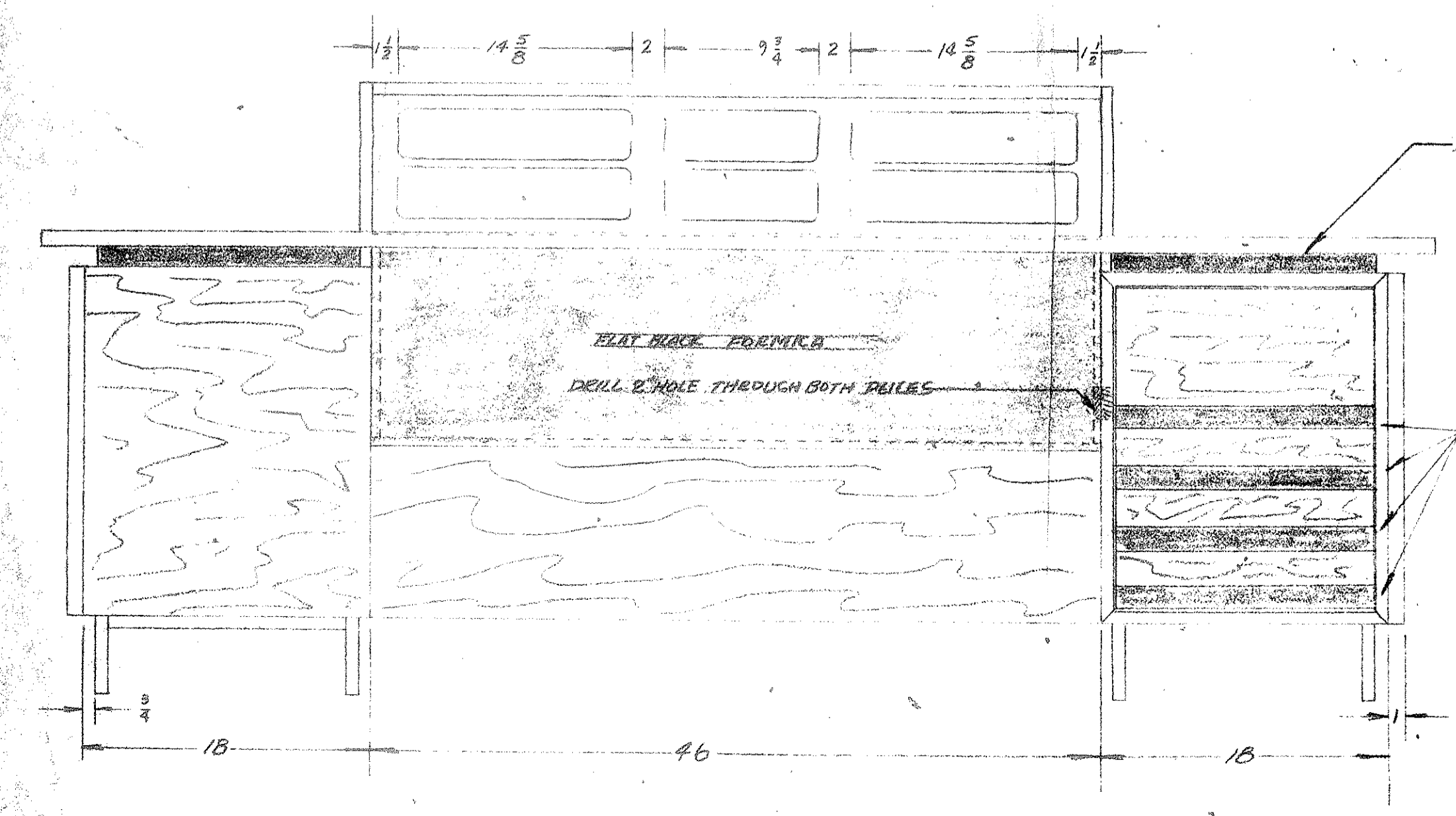
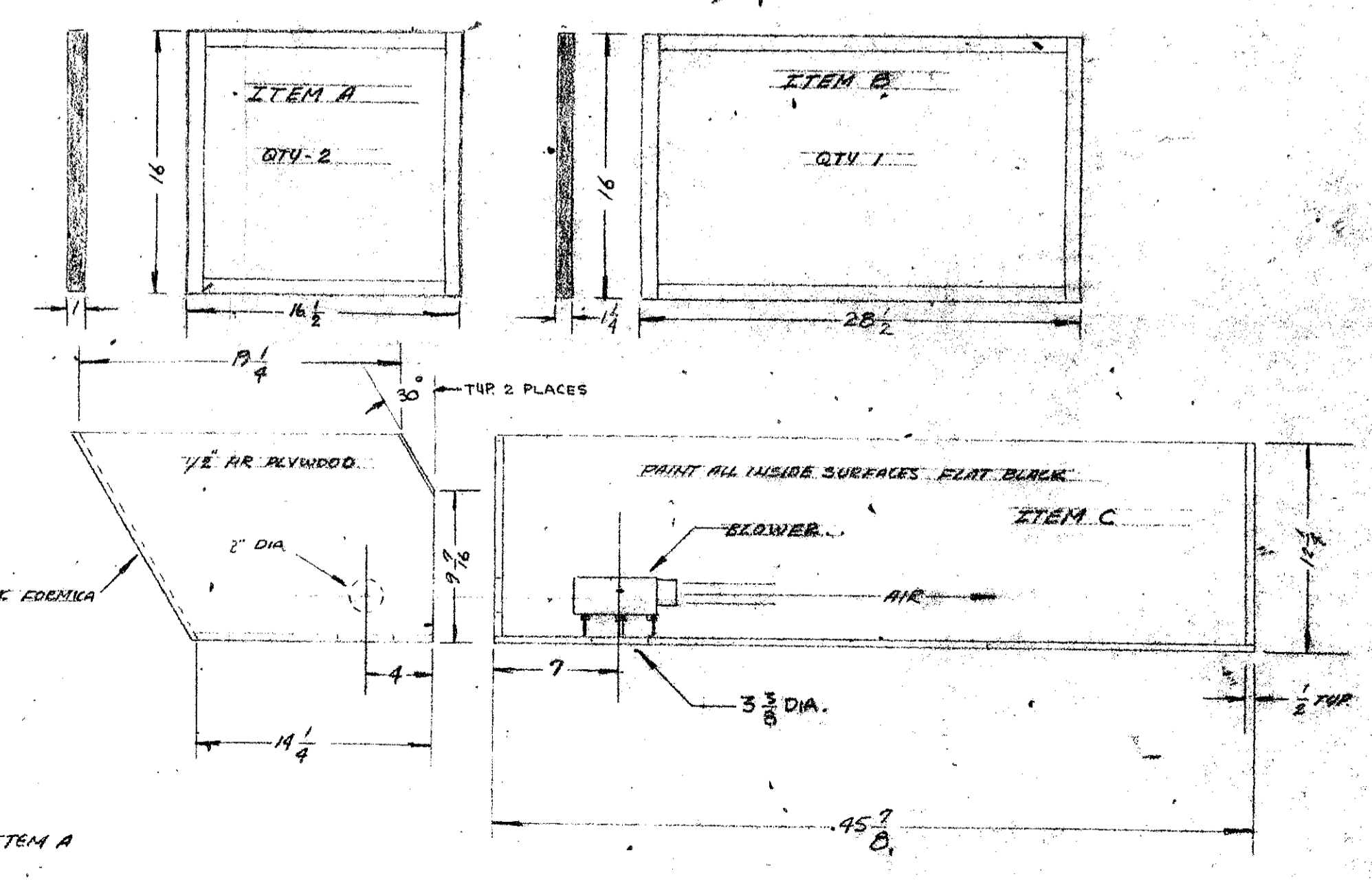
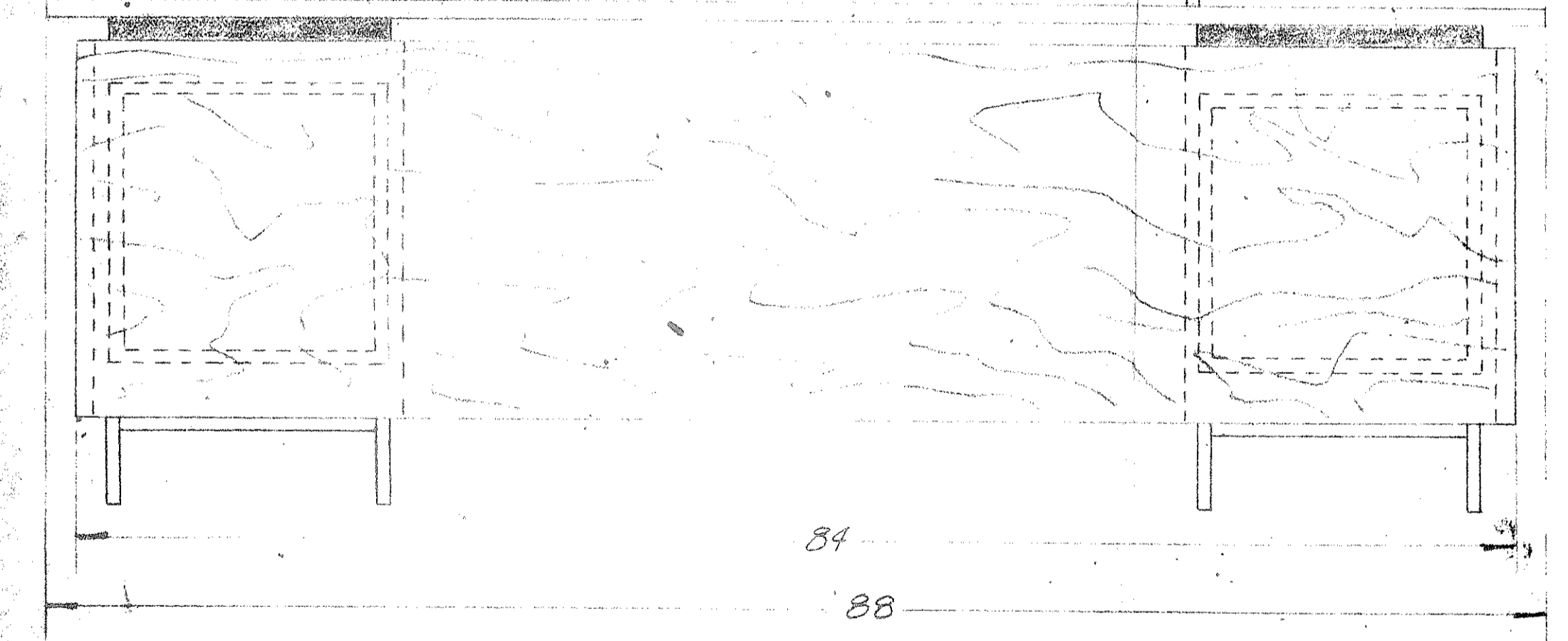
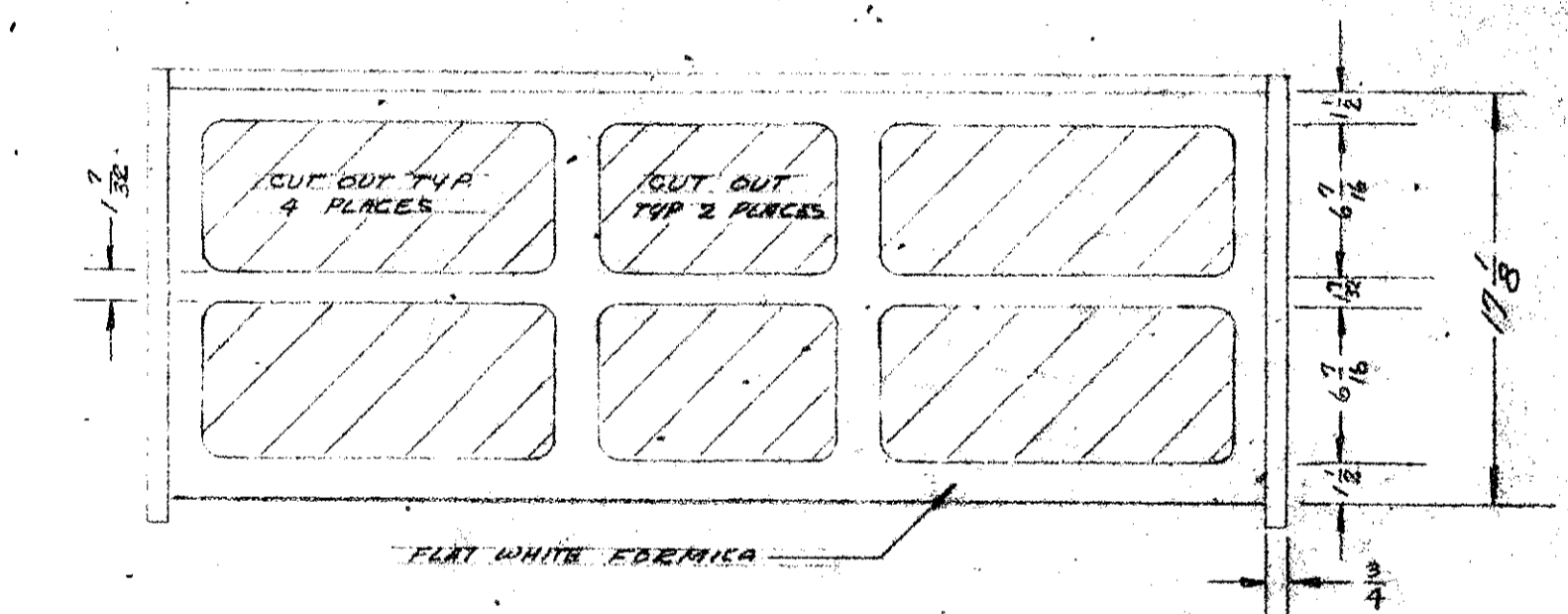
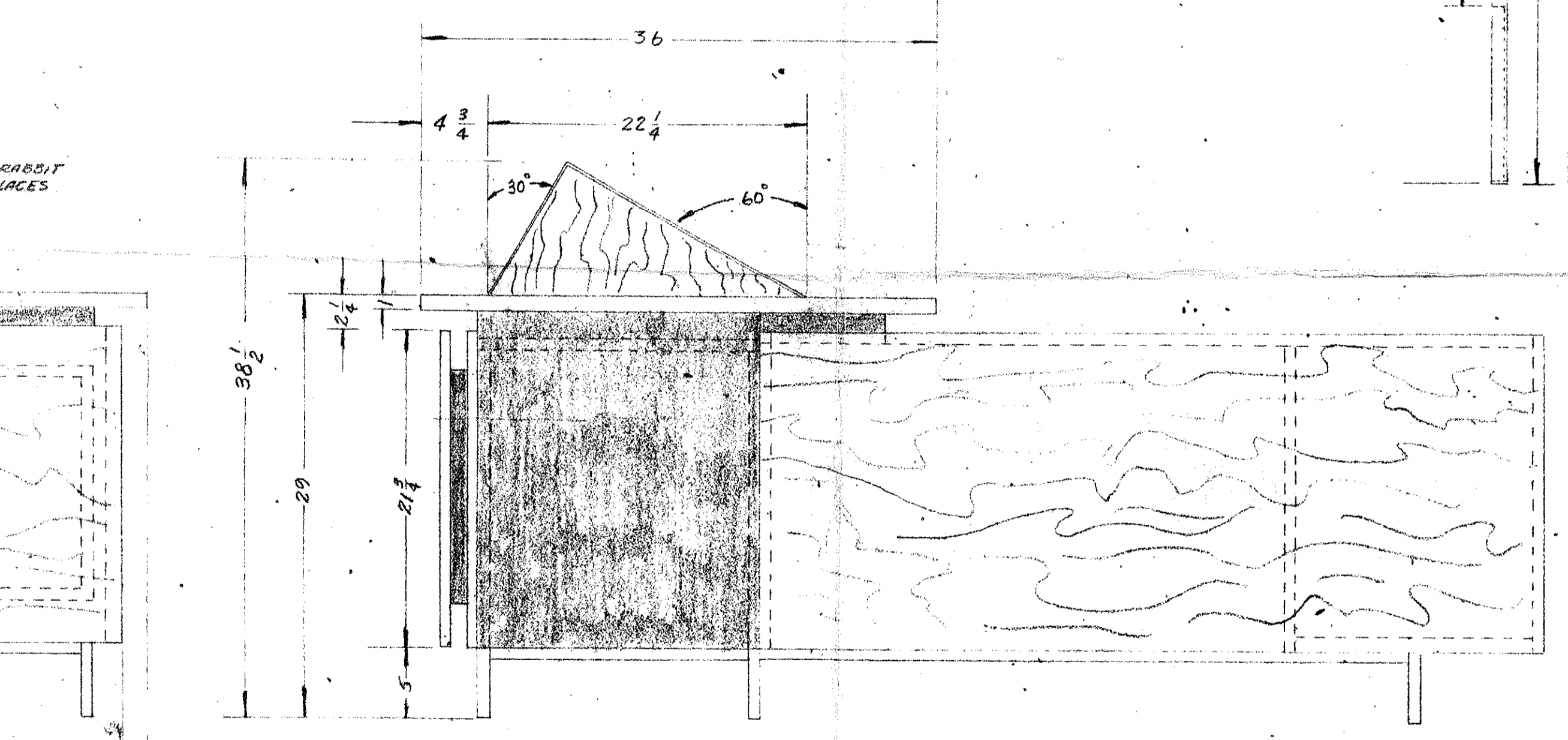
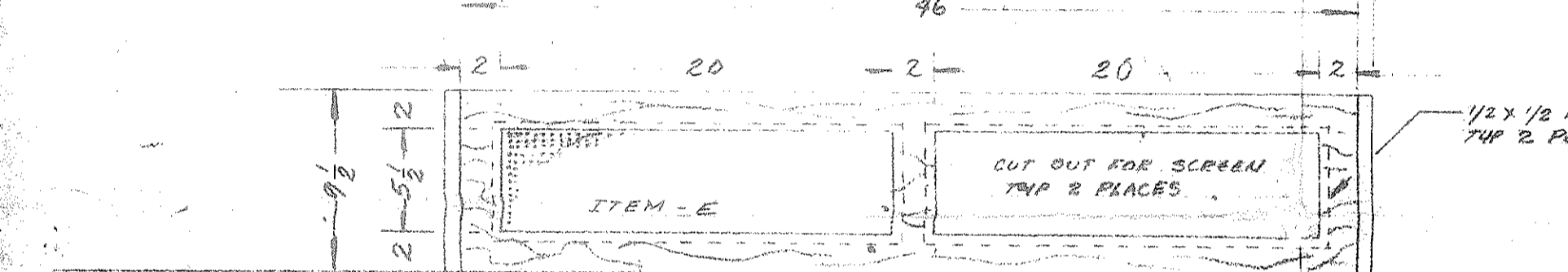
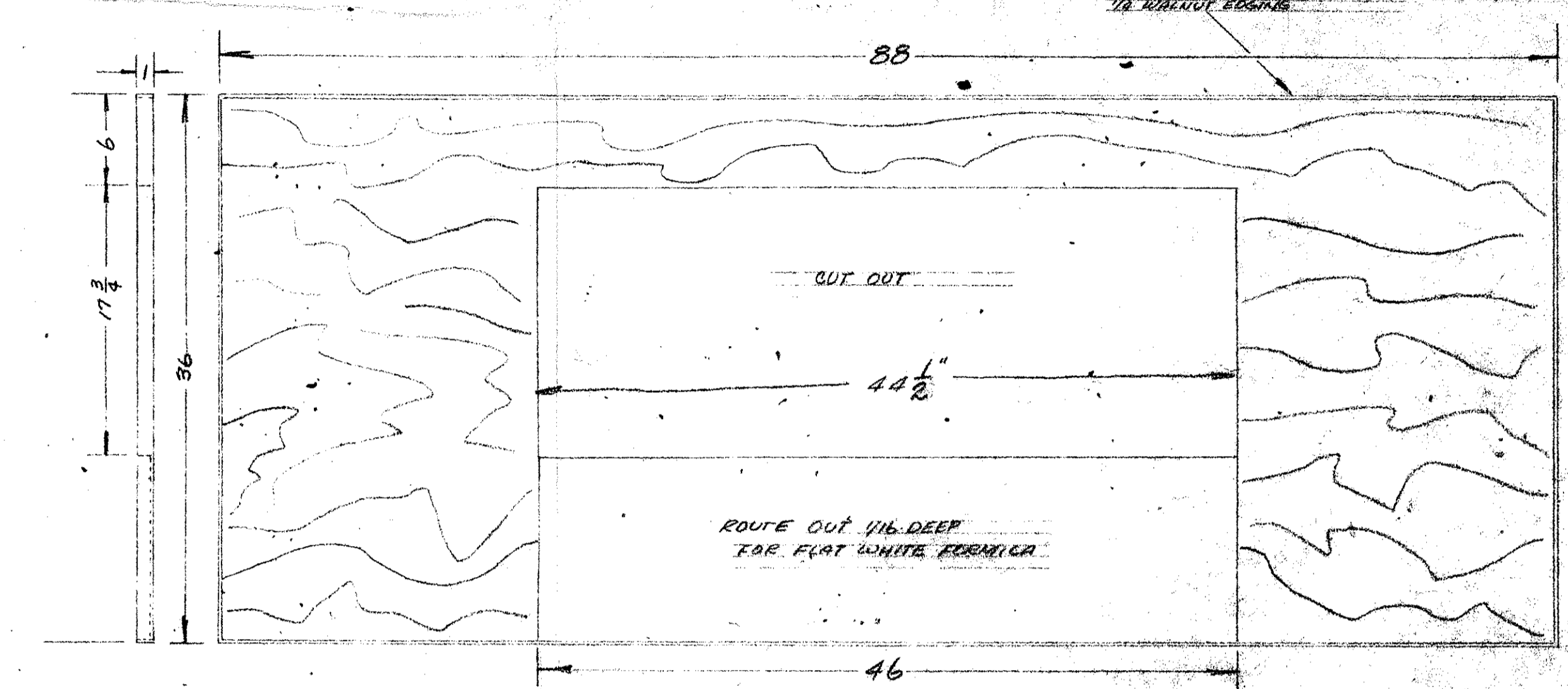
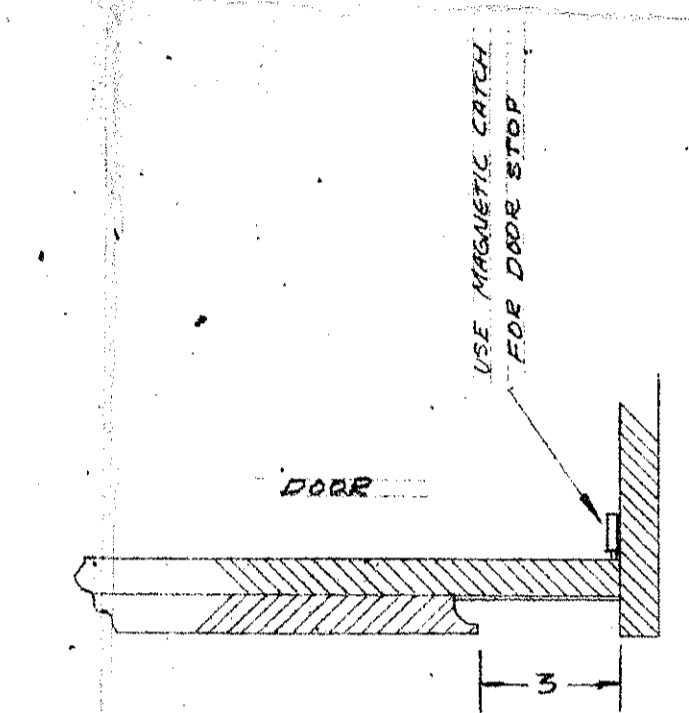
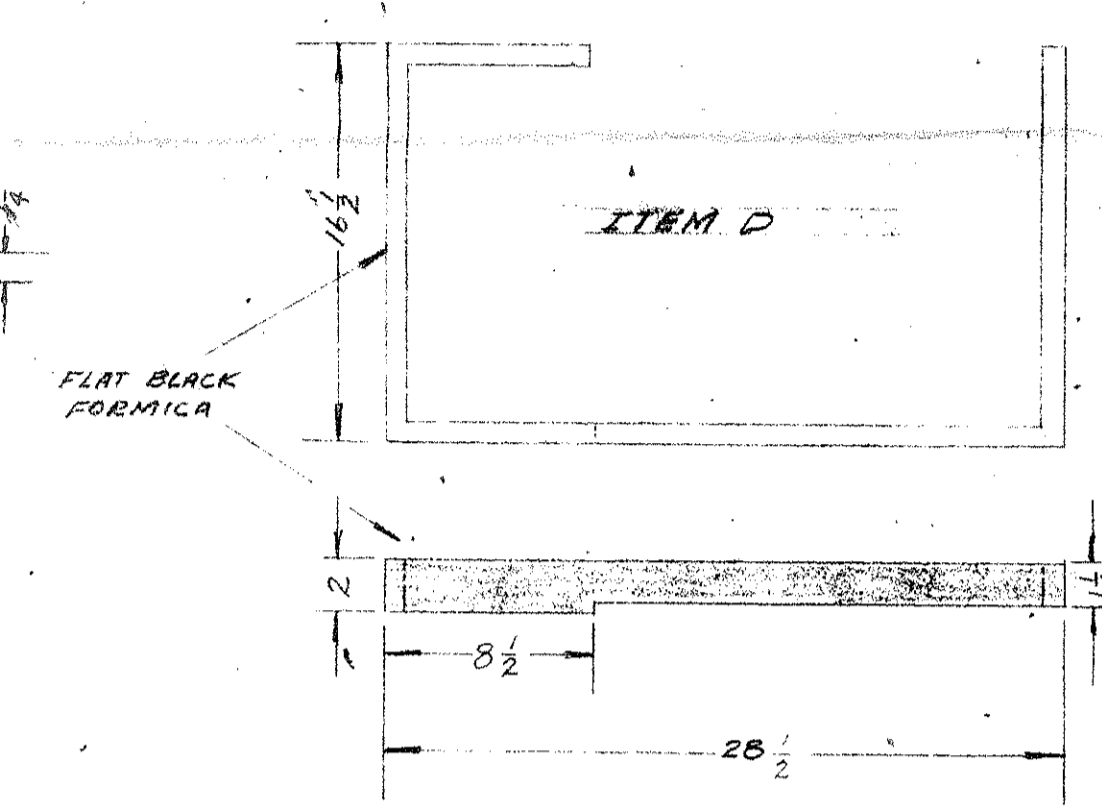
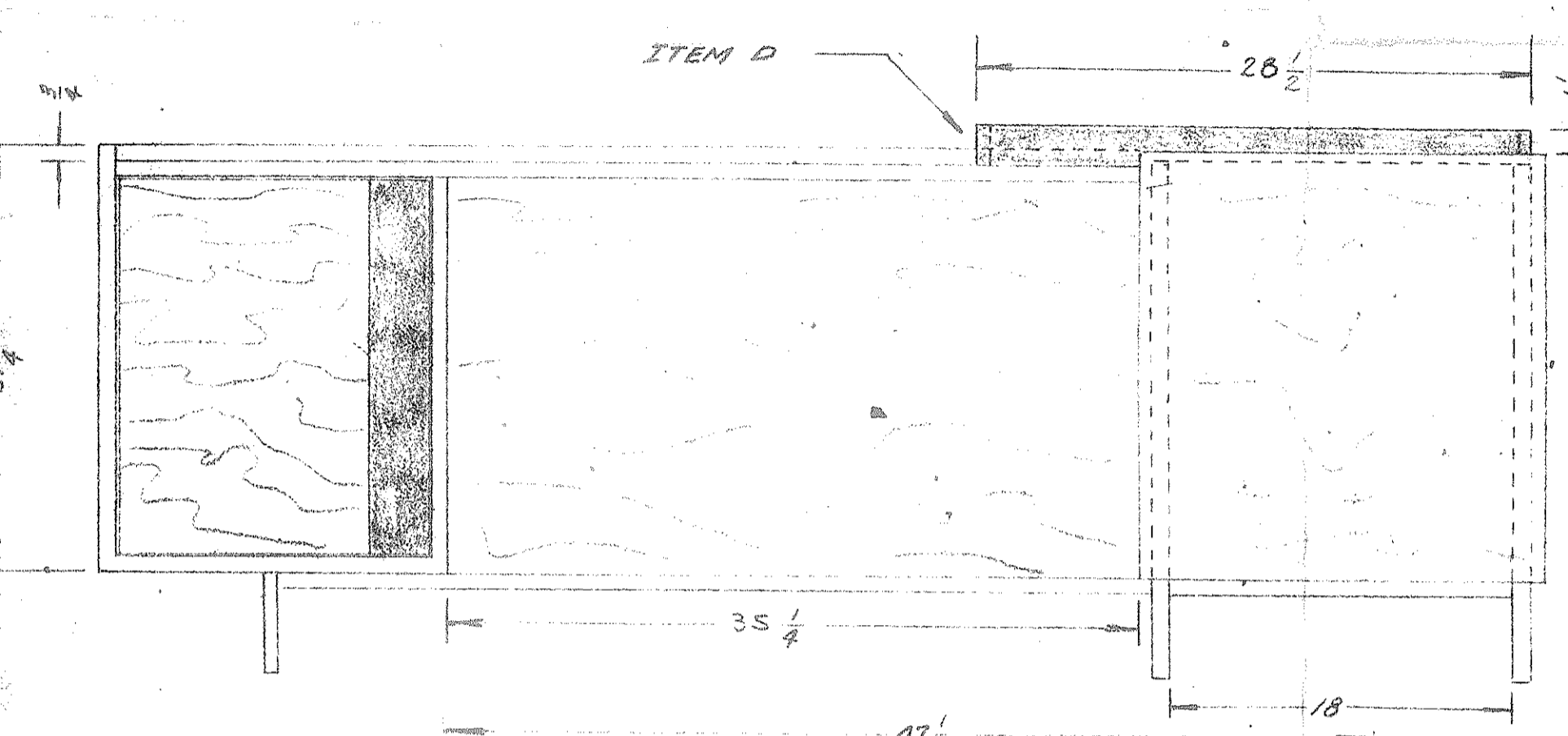
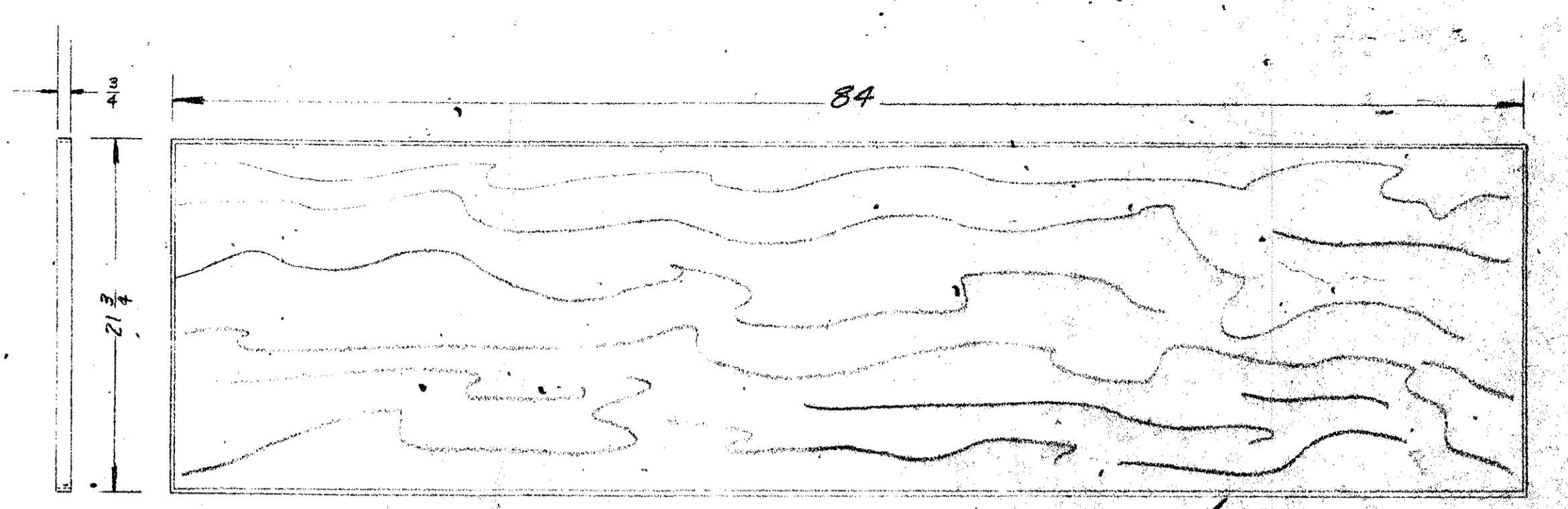

ITEM B  
 TOP DRAWER MUST BE 8" INSIDE. OTHER DRAWERS ARE TO BE EVENLY SPACED  
 FLAT BLACK FORMICA INSERTS

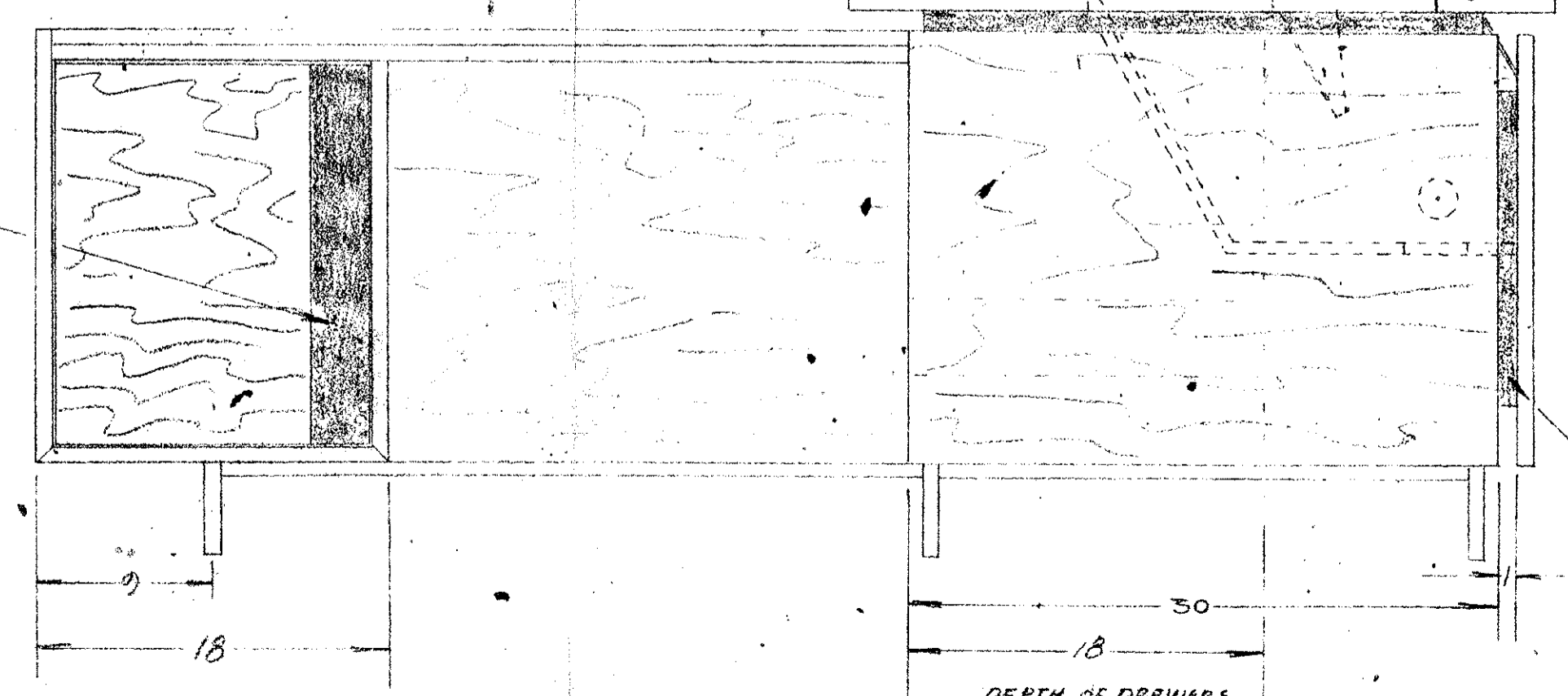

AMATEUR OPERATOR'S DESK  
 DRAWN BY RON COLLIER  
 SCALE 1/8" = 1" JAN 26, 1962